

### DESCRIPTION

The Industrial Oval Gear Meter is a modular flow meter design, economical yet highly accurate and rugged. Due to the rugged nature of this particular flow measurement technology, the industrial Oval Gear Meter can be used in a number of applications where conventional meters are not acceptable.

### OPERATION PRINCIPLE

Fluid enters the inlet port and then passes through the metering chamber. Inside the chamber, fluid forces the internal gears to rotate before exiting through the outlet port. Each rotation of the gears displaces a specific volume of fluid. As the gears rotate, a magnet on each end of the gear pass a reed switch in the top-mounted register's circuit board. The reed switches send pulses to the microprocessor in the register to change the LED display segments. The oval gear meter can be used in conjunction with a variety of industrial registers.



### ADVANTAGES

- Highest quality, made in Germany
- Cost effective and commercially competitive product due to the most up to date automated production techniques
- Wide range of sizes, materials, displays and component options
- Most items ex stock for fast delivery, benefit from low shipping cost
- Local support, worldwide

### FEATURES

- High accuracy and repeatability
- Insensitive to viscosity change – Maintains accuracy
- Not affected by pulsating flows
- Can be mounted in tight pipework and any orientation
- Most industrial communications and outputs available
- Custom options available
- ATEX approval, FDA conformity



### APPLICATIONS

Whether the liquid being measured is very viscous or highly corrosive, the oval gear meter can handle it. The industrial oval gear is designed for a variety of chemical applications including petroleum based fluids, water solutions, and any other liquid compatible with the materials of construction.

## PROCESS CONNECTIONS

| Port Size | Housing Material | NPT/BSP            | ANSI 150#        | ANSI 300#        | DIN              | Tri-Clamp®            |
|-----------|------------------|--------------------|------------------|------------------|------------------|-----------------------|
| 1/4 in.   | PVDF             | 230 psi (16 bar)   | —                | —                | —                | —                     |
|           | Stainless        | 1450 psi (100 bar) |                  |                  |                  |                       |
|           | Aluminum         | 940 psi (65 bar)   | 275 psi (20 bar) | n/a              | 230 psi (16 bar) | 230 psi (16 bar)<br>— |
| 1/2 in.   | Stainless        | 3000 psi (210 bar) | 275 psi (20 bar) | n/a              | 230 psi (16 bar) | 230 psi (16 bar)<br>— |
|           | Aluminum         | 2000 psi (140 bar) |                  |                  |                  |                       |
| 3/4 in.   | PVDF             | 230 psi (16 bar)   | —                | —                | —                | —                     |
|           | Stainless        | 3000 psi (210 bar) | 275 psi (20 bar) | 790 psi (55 bar) | 230 psi (16 bar) | 230 psi (16 bar)      |
|           | Aluminum         | 2000 psi (140 bar) | —                | n/a              | —                | —                     |
| 1 in.     | Stainless        | 3000 psi (210 bar) | 275 psi (20 bar) | 790 psi (55 bar) | 230 psi (16 bar) | 230 psi (16 bar)      |
|           | Aluminum         | 2000 psi (140 bar) |                  | n/a              |                  |                       |
| 1 in. HF  | PVDF             | 230 psi (16 bar)   | —                | —                | —                | —                     |
|           | Stainless        | 3000 psi (210 bar) | 275 psi (20 bar) | 790 psi (55 bar) | 230 psi (16 bar) | 230 psi (16 bar)      |
|           | Aluminum         | 2000 psi (140 bar) | —                | n/a              | —                | —                     |
| 1-1/2 in. | Stainless        | 720 psi (50 bar)   | 275 psi (20 bar) | 720 psi (50 bar) | 230 psi (16 bar) | 230 psi (16 bar)      |
|           | Aluminum         | 720 psi (50 bar)   |                  | n/a              |                  | —                     |
| 2 in.     | Stainless        | 580 psi (40 bar)   | 275 psi (20 bar) | 580 psi (40 bar) | 230 psi (16 bar) | 145 psi (10 bar)      |
|           | Aluminum         | 580 psi (40 bar)   |                  | n/a              |                  | —                     |
| 3 in.     | Stainless        | 360 psi (25 bar)   | 275 psi (20 bar) | 360 psi (25 bar) | 230 psi (16 bar) | 145 psi (10 bar)      |
|           | Aluminum         | 360 psi (25 bar)   |                  | n/a              |                  | —                     |

High pressure ratings on request

## SPECIFICATIONS

| Housing and connection by size |  |
|--------------------------------|--|
| Sizes                          | 1/4 in., 1/2 in., 3/4 in., 1 in., 1 in. HF, 1-1/2 in., 2 in. and 3 in. |
| Aluminum                       | NPT, BSP, 150# flange, DIN flange EN 1092-1/05                         |
| Stainless                      | NPT, BSP, 150# or 300# flange, DIN flange Tri-Clamp®                   |
| PVDF                           | BSP, NPT   |

| Operating temperature             | Housing                                 | Oval gears                              |
|-----------------------------------|---|---|
| Stainless steel                   | -22 °F ... +240 °F (-30 °C ... +120 °C) | -22 °F ... +240 °F (-30 °C ... +120 °C) |
| Plastic (PPS/LCP)                 | -22 °F ... +176 °F (-30 °C ... +80 °C)  | -22 °F ... +176 °F (-30 °C ... +80 °C)  |
| Aluminum                          | -22 °F ... +240 °F (-30 °C ... +120 °C) |   |
| PVDF                              | +14 °F ... +140 °F (-10 °C ... +60 °C)  |   |
| Storage temperature for all units | -67 °F / +257 °F (-55 °C / +125 °C)     |   |

| Viscosity   |
|---|
| Max 1000 mPas with standard rotors / 500000 mPas with high viscosity rotors |

## FLOW RANGE

| Port Size   | l/min        | gpm           | Fluid viscosity | Accuracy (%) | Accuracy PVDF (%) | Repeatability (%) |
|-------------|--------------|---------------|-----------------|--------------|-------------------|-------------------|
| 1/4 in. LF* | 0.04 ... 1.6 | 0.01 ... 0.4  | >5.0 cP         | ±1.0         | ±1.5              | ±0.03             |
|             | 0.09 ... 1.6 | 0.02 ... 0.4  | <5.0 cP         | ±1.5         | ±2.5              | ±0.03             |
| 1/4 in.*    | 0.25 ... 8.3 | 0.067 ... 2.2 | >5.0 cP         | ±1.0         | ±1.5              | ±0.03             |
|             | 0.44 ... 8.3 | 0.11 ... 2.2  | <5.0 cP         | ±1.5         | ±2.5              | ±0.03             |
| 1/2 in.     | 1 ... 30     | 0.25 ... 8.0  | >5.0 cP         | ±0.5         | —                 | ±0.03             |
|             | 2 ... 25     | 0.5 ... 6.6   | <5.0 cP         | ±1.5         | —                 | ±0.03             |
| 3/4 in.     | 2 ... 60     | 0.5 ... 16    | >5.0 cP         | ±0.5         | ±1.5              | ±0.03             |
|             | 4.5 ... 53   | 1.2 ... 14    | <5.0 cP         | ±1.5         | ±2.5              | ±0.03             |
| 1 in.       | 2.3 ... 68   | 0.6 ... 18    | >5.0 cP         | ±0.5         | ±1.5              | ±0.03             |
|             | 5.3 ... 60   | 1.4 ... 16    | <5.0 cP         | ±1.5         | ±2.5              | ±0.03             |
| 1 in. HF    | 5.7 ... 170  | 1.5 ... 45    | >5.0 cP         | ±0.5         | —                 | ±0.03             |
|             | 9.5 ... 150  | 2.6 ... 40    | <5.0 cP         | ±1.5         | —                 | ±0.03             |
|             | 5.7 ... 120  | 1.5 ... 31    | >5.0 cP         | —            | ±1.5              | ±0.03             |
|             | 9.5 ... 120  | 2.6 ... 31    | <5.0 cP         | —            | ±2.5              | ±0.03             |
| 1-1/2 in.   | 9.5 ... 245  | 2.5 ... 65    | >5.0 cP         | ±0.5         | —                 | ±0.03             |
|             | 15 ... 227   | 4.0 ... 60    | <5.0 cP         | ±1.5         | —                 | ±0.03             |
| 2 in.       | 15 ... 380   | 4.0 ... 100   | >5.0 cP         | ±0.5         | —                 | ±0.03             |
|             | 23 ... 380   | 6.0 ... 100   | <5.0 cP         | ±1.0         | —                 | ±0.03             |
| 3 in.       | 20 ... 700   | 5.0 ... 185   | >5.0 cP         | ±0.5         | —                 | ±0.03             |
|             | 38 ... 700   | 10 ... 185    | <5.0 cP         | ±1.0         | —                 | ±0.03             |

\*Special calibration with the following viscosities is possible for the 1/8 in. and 1/4 in. meters.

| Part # | Medium     | Viscosity                         | Accuracy (%) |
|--------|------------|-----------------------------------|--------------|
| CAL 1  | ISO VG 2   | 2.7 cP (3.3 mm <sup>2</sup> /sec) | ±1.0         |
| CAL 2  | ISO VG 5   | 6.4 cP (7.6 mm <sup>2</sup> /sec) | ±0.8         |
| CAL 3  | ISO VG 10  | 18 cP (20.5 mm <sup>2</sup> /sec) | ±0.6         |
| CAL 4  | ISO VG 32  | 75 cP (87 mm <sup>2</sup> /sec)   | ±0.4         |
| CAL 5  | ISO VG 100 | 290 cP (330 mm <sup>2</sup> /sec) | ±0.3         |

## MATERIAL OF CONSTRUCTION

| Port Size  | Housing | Cover   | Spindle | Gears      | Bearings | O-Ring | Bolts  |       |
|------------|---------|---------|---------|------------|----------|--------|--------|-------|
| 1/4 in.    | 316 SS  | 316 SS  | 316 SS  | 316 SS     | Graphite | Viton  | 316 SS |       |
|            | 606 Al  | 6061 Al |         | PPS        |          |        |        |       |
| 1/2 in.    | 316 SS  | 316 SS  |         | 316 SS     | Graphite |        |        |       |
|            | 6061 Al | 6061 Al |         | LCP or PPS |          |        |        |       |
| 3/4 in.    | 316 SS  | 316 SS  |         | 316 SS     | Graphite |        |        | Aflas |
|            | 6061 Al | 6061 Al |         | LCP or PPS |          |        |        |       |
| 1 in.      | 316 SS  | 316 SS  |         | 316 SS     | Graphite | EPDM   |        |       |
|            | 6061 Al | 6061 Al |         | LCP or PPS |          |        |        |       |
| 1 in. HF   | 316 SS  | 316 SS  |         | 316 SS     | Graphite | Kalrez |        |       |
|            | 6061 Al | 6061 Al |         | PPS        |          |        |        |       |
| 1- 1/2 in. | 316 SS  | 316 SS  |         | 316 SS     | Graphite |        |        |       |
|            | 6061 Al | 6061 Al |         | PPS        |          |        |        |       |
| 2 in.      | 316 SS  | 316 SS  |         | 316 SS     | Graphite |        |        |       |
|            | 6061 Al | 6061 Al |         | PPS        |          |        |        |       |
| 3 in.      | 316 SS  | 316 SS  |         | 316 SS     | Graphite |        |        |       |
|            | 6061 Al | 6061 Al |         | PPS        |          |        |        |       |

**NOTE:** All PVDF devices are supplied with Hastelloy-C spindles.

**DIMENSIONS**

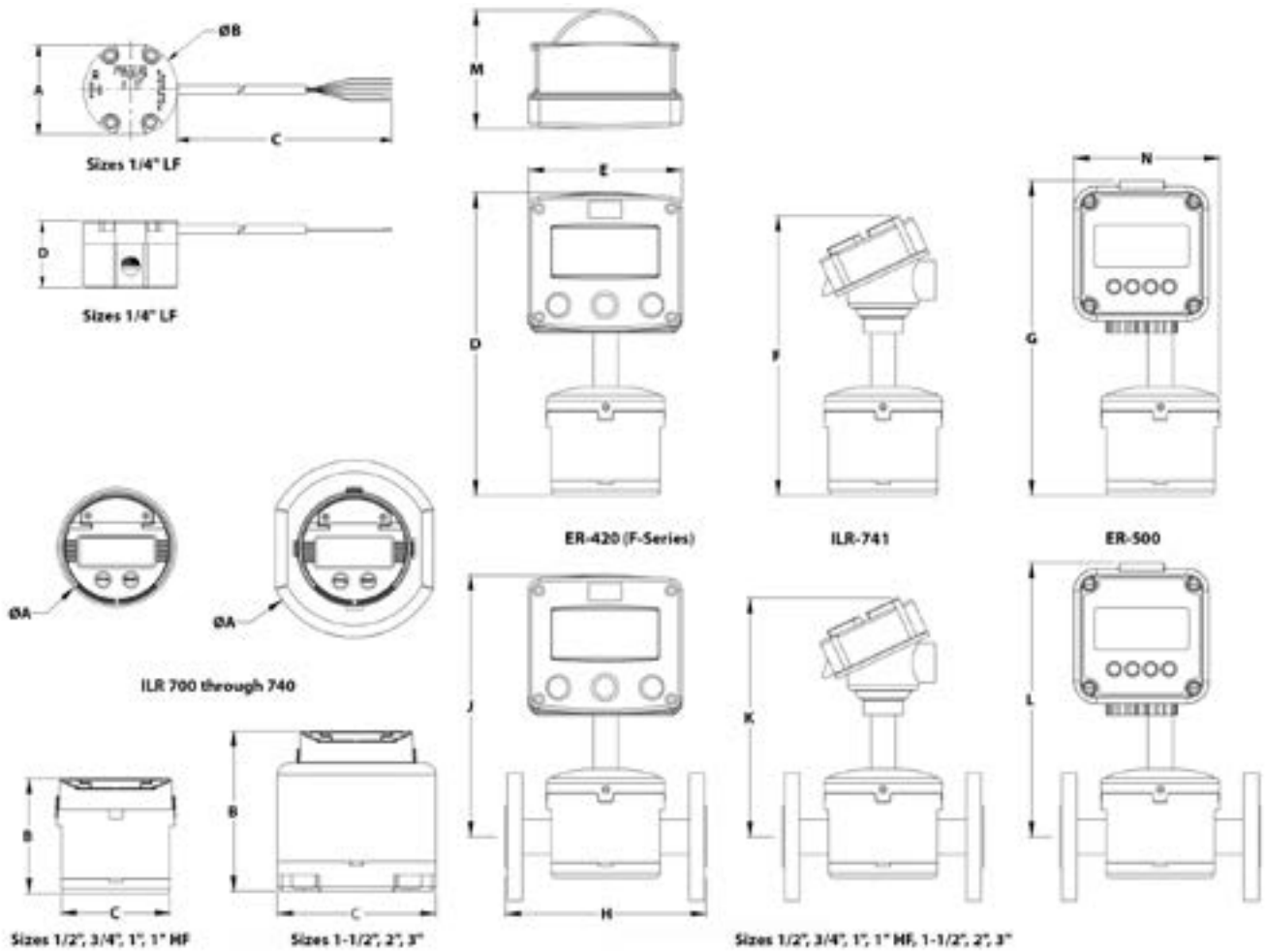

| Port Size  | A                    | B                      | C                    | D                       | E                    | F                       | G                       | H                     | J                      | K                      | L                      | M                      | N                      |
|------------|----------------------|------------------------|----------------------|-------------------------|----------------------|-------------------------|-------------------------|-----------------------|------------------------|------------------------|------------------------|------------------------|------------------------|
| 1/4 in. LF | 2.05 in.<br>(52 mm)  | 2.17 in.<br>(55 mm)    | 118 in.<br>(3000 mm) | 1.54 in.<br>(39 mm)     | —                    | —                       | —                       | —                     | —                      | —                      | —                      | —                      | —                      |
| 1/4 in.    | 2.05 in.<br>(52 mm)  | 2.17 in.<br>(55 mm)    | 118 in.<br>(3000 mm) | 1.54 in.<br>(39 mm)     | —                    | —                       | —                       | —                     | —                      | —                      | —                      | —                      | —                      |
| 1/2 in.    | 3.94 in.<br>(100 mm) | 3.44 in.<br>(87.5 mm)  | 3.62 in.<br>(92 mm)  | 9.70 in.<br>(246.4 mm)  | 5.12 in.<br>(130 mm) | 8.93 in.<br>(226.8 mm)  | 10.10 in.<br>(256.5 mm) | 6.69 in.<br>(170 mm)  | 8.45 in.<br>(214.6 mm) | 7.68 in.<br>(195.1 mm) | 8.89 in.<br>(225.8 mm) | 3.94 in.<br>(100.2 mm) | 4.84 in.<br>(122.9 mm) |
| 3/4 in.    | 3.94 in.<br>(100 mm) | 3.84 in.<br>(97.5 mm)  | 3.62 in.<br>(92 mm)  | 10.10 in.<br>(256.5 mm) | 5.12 in.<br>(130 mm) | 9.33 in.<br>(236.9 mm)  | 10.50 in.<br>(266.7 mm) | 6.69 in.<br>(170 mm)  | 8.70 in.<br>(220.9 mm) | 7.93 in.<br>(201.4 mm) | 9.14 in.<br>(232.2 mm) | 3.94 in.<br>(100.2 mm) | 4.84 in.<br>(122.9 mm) |
| 1 in.      | 3.94 in.<br>(100 mm) | 3.84 in.<br>(97.5 mm)  | 3.62 in.<br>(92 mm)  | 10.10 in.<br>(256.5 mm) | 5.12 in.<br>(130 mm) | 9.33 in.<br>(236.9 mm)  | 10.50 in.<br>(266.7 mm) | 6.69 in.<br>(170 mm)  | 8.70 in.<br>(220.9 mm) | 7.93 in.<br>(201.4 mm) | 9.14 in.<br>(232.2 mm) | 3.94 in.<br>(100.2 mm) | 4.84 in.<br>(122.9 mm) |
| 1 in. HF   | 3.94 in.<br>(100 mm) | 3.89 in.<br>(98.9 mm)  | 3.62 in.<br>(92 mm)  | 10.15 in.<br>(257.8 mm) | 5.12 in.<br>(130 mm) | 9.38 in.<br>(238.3 mm)  | 10.55 in.<br>(268.0 mm) | 6.69 in.<br>(170 mm)  | 8.60 in.<br>(218.4 mm) | 7.83 in.<br>(198.8 mm) | 9.04 in.<br>(229.6 mm) | 3.94 in.<br>(100.2 mm) | 4.84 in.<br>(122.9 mm) |
| 1-1/2 in.  | 5.51 in.<br>(140 mm) | 4.93 in.<br>(125.3 mm) | 4.92 in.<br>(125 mm) | 11.15 in.<br>(283.2 mm) | 5.12 in.<br>(130 mm) | 10.38 in.<br>(263.7 mm) | 11.51 in.<br>(292.4 mm) | 8.35 in.<br>(212 mm)  | 8.90 in.<br>(226.1 mm) | 8.13 in.<br>(206.5 mm) | 9.31 in.<br>(236.5 mm) | N/A                    | N/A                    |
| 2 in.      | 5.91 in.<br>(150 mm) | 5.34 in.<br>(135.6 mm) | 5.28 in.<br>(134 mm) | 11.60 in.<br>(294.6 mm) | 5.12 in.<br>(130 mm) | 10.83 in.<br>(275.1 mm) | 11.96 in.<br>(303.8 mm) | 10.39 in.<br>(264 mm) | 9.16 in.<br>(232.7 mm) | 8.39 in.<br>(213.1 mm) | 9.57 in.<br>(243.1 mm) | N/A                    | N/A                    |
| 3 in.      | 8.27 in.<br>(210 mm) | 6.35 in.<br>(162 mm)   | 7.09 in.<br>(180 mm) | 12.57 in.<br>(319.3 mm) | 5.12 in.<br>(130 mm) | 11.80 in.<br>(299.7 mm) | 12.93 in.<br>(328.4 mm) | 13.54 in.<br>(344 mm) | 9.58 in.<br>(243.3 mm) | 8.81 in.<br>(223.8 mm) | 9.99 in.<br>(253.8 mm) | N/A                    | N/A                    |

**NOTE:** ILR register series not compatible with 3 in. meter.

**PRESSURE DROP VS. FLOW RATE**

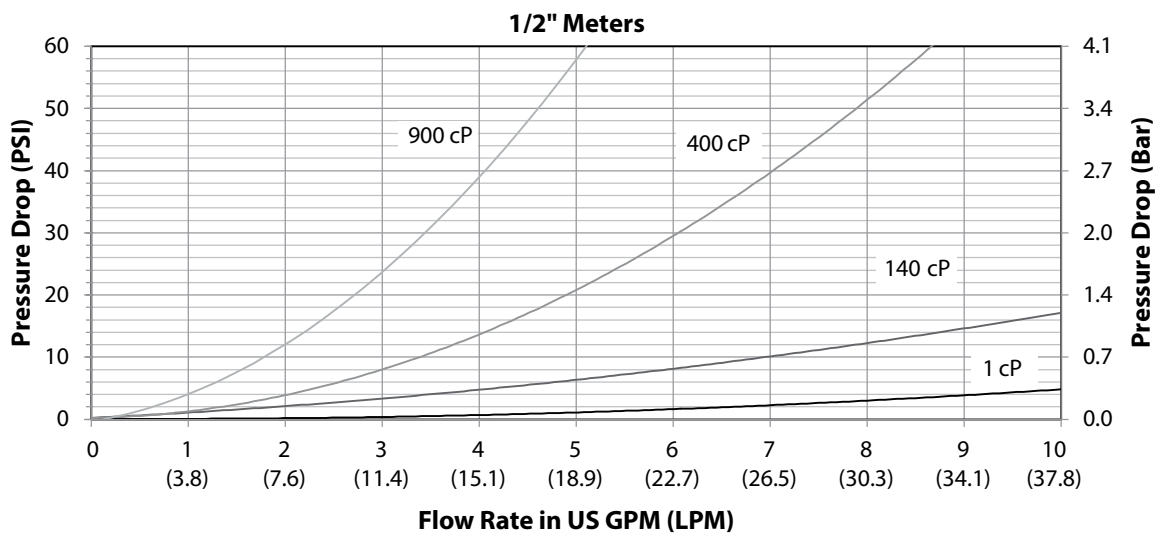
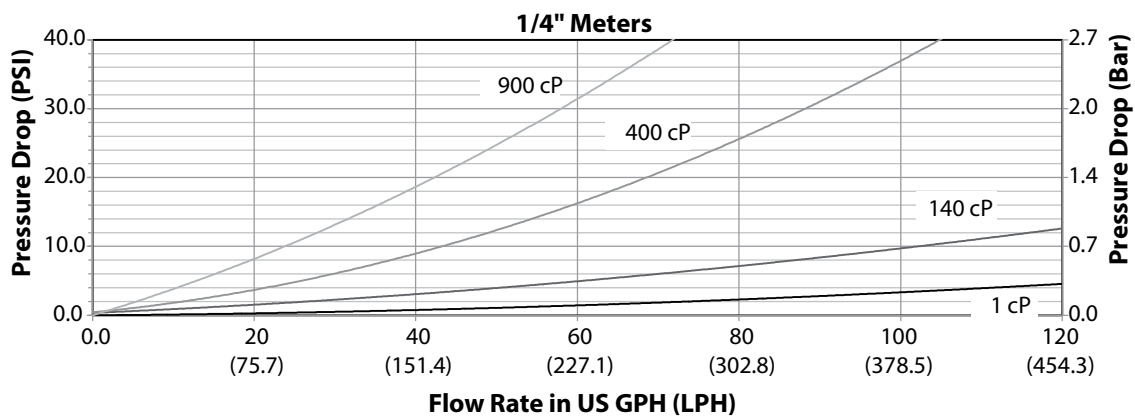
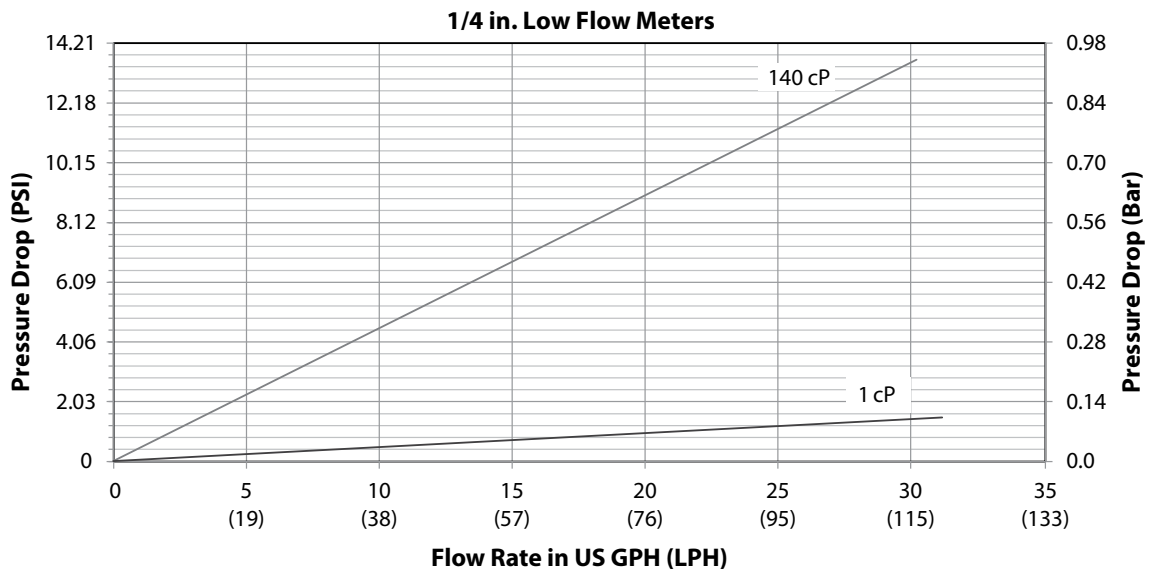

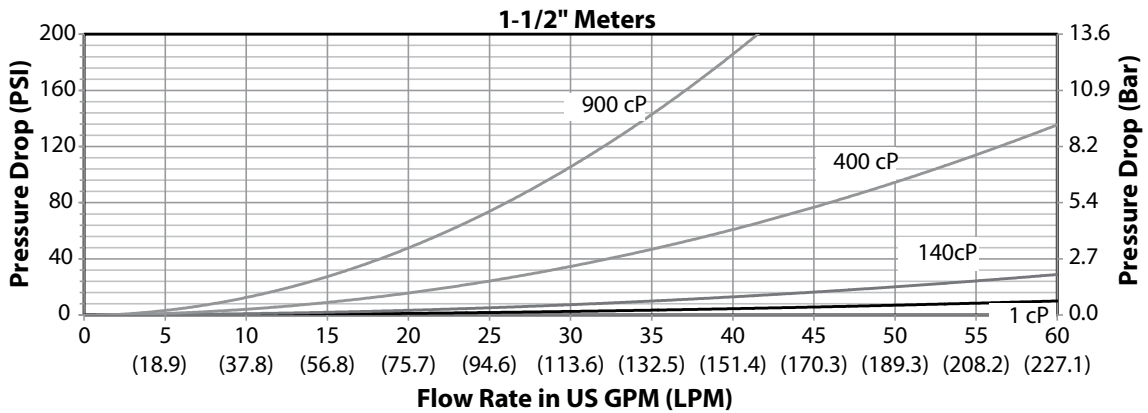
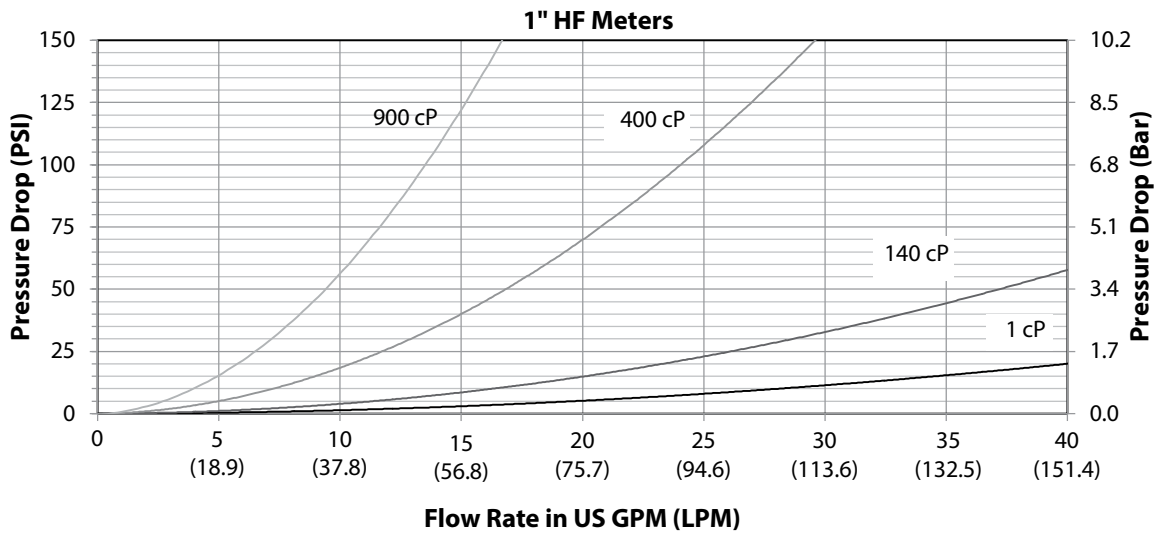
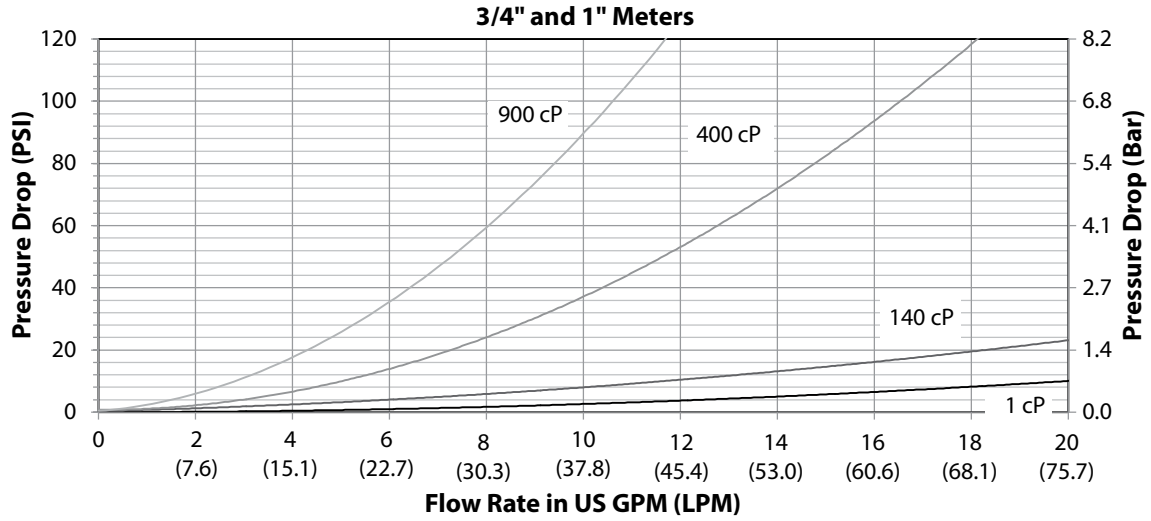

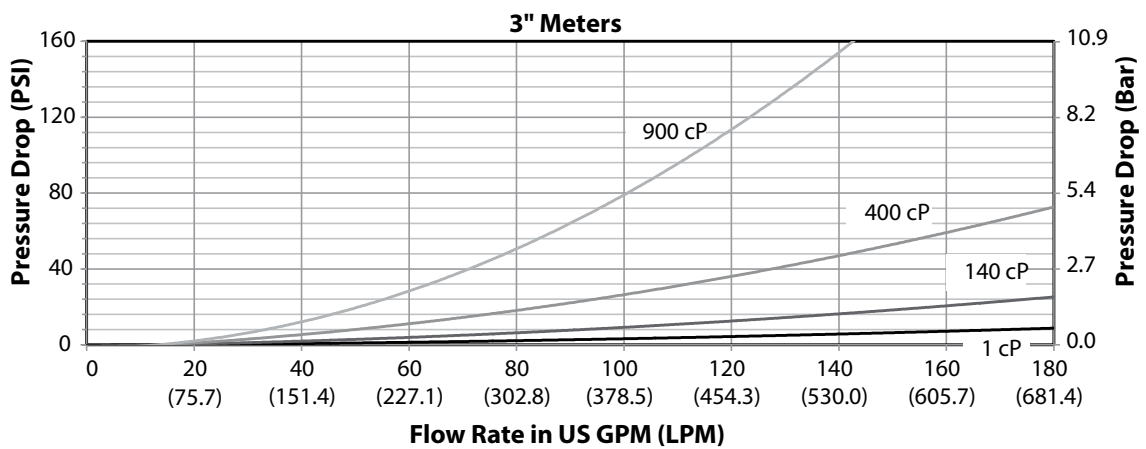
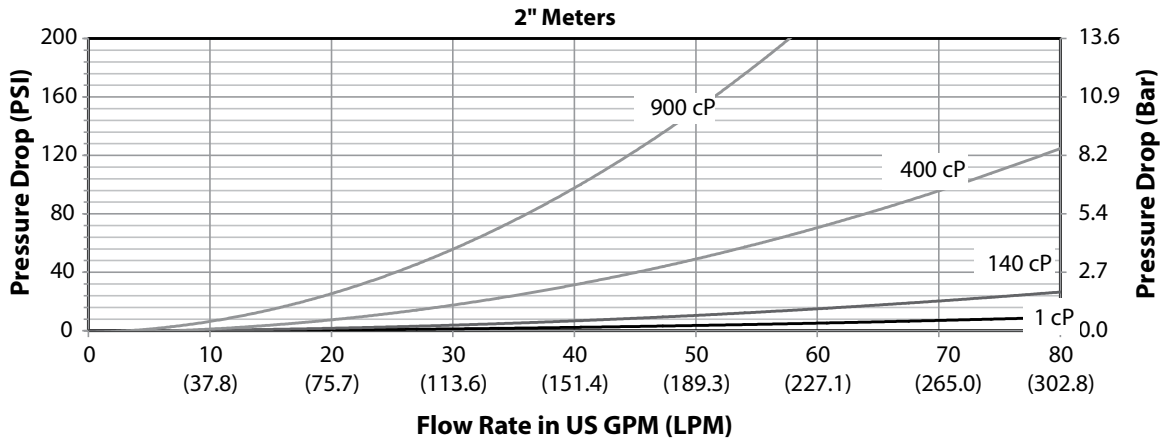

## INDUSTRIAL LINE REGISTERS

### Type ILR 700, 701, 740, 741, 750

#### Description

The electronic register module contains a microprocessor board powered by a lithium battery. It can be programmed to batch in liters, pints, quarts, or gallons and will totalize in liters or gallons. A calibration factor and unit of measure are programmed during factory test. Unlike mechanical registers, these units can be electronically recalibrated in the field when necessary. A 6 digit LC display, accurate to three decimal places, shows the exact amount of fluid that has passed through the meter. The entire register module is protected from normal wear and tear by a rugged, shock resistant housing.

If the total dispensed exceeds 999.999 then the display will shift and only 2 digits will be displayed after the decimal point, 9999.99 and will continue to shift to the maximum value of 999999. After reaching 999999 the batch totalizer will rollover to 0.000. The batch totalizer is reset to zero when the reset button is depressed.

The register also has a resettable totalizer that requires that the total and reset button both be depressed to reset (hold the "Total" button, then press the "Reset" button to reset this totalizer while resettable totalize is displayed). This would be used for multiple batch totalization purposes.

The register's life time totalizer is 11 digits and will either be in gallons or liters based on the unit of measure selected. Pushing and holding the total button while the life time totalizer is displayed will display the full 11 digit life time totalizer value.

#### Operation

Industrial Oval Gear Meter has magnets on the gears that cause the reed switches to send pulses to the register as they rotate.

The register is in a sleep mode until it detects these pulses caused by fluid going through the meter. The micro-processor in the register then measures the flow and will display either the batch totalization or the flow rate of the fluid going through the meter on the 6 digit display.

The registers batch totalizer is a 6 digit display with three places of resolution after the decimal point.



#### Features

- Large six digit LCD display
- Display in liters, pints, quarts or gallons, freely programmable
- 11 digits, non-resettable lifetime totalizer and 6 digits, resettable totalizer
- ILR series: -4 °F ... +176 °F (-20 °C ... +80 °C)
- Replaceable long life battery
- Calibration factor saved in non-volatile memory
- 9 point linearization (ILR 750, ILR 701). Test medium is water – please contact your sales representative for calibrations with other liquids
- Scalable pulse output (ILR 750)
- 4 ... 20 mA output (ILR 750)
- Protection class IP65

| Register Model                               | Register features  | Temperature Ranges            |
|--|--|-------------------------------|
| ILR 700 Standard register                    | Flow rate or totalizer display selectable in the programming menu<br>Selectable unit of measure  | -4 ... 176 °F (-20 ... 80 °C) |
| ILR 701                                      | 9 point linearization  |                               |
| ILR 750 pulse output<br>+ 4 ... 20 mA output | Scalable pulse output<br>Ability to set pulse output length<br>Analog 4 ... 20 mA output representing the flow rate of the meter<br>Minimum and maximum values can be set for analog output<br>9 point linearization |                               |

**NOTE:** The ILR 701 and 750 all have the standard features of the ILR 700.

|                                   |  |                                 |
|-----------------------------------|--|---------------------------------|
| ILR 740 Transmitter               | Transmitter (reed switch)  | -40 ... 257 °F (-40 ... 125 °C) |
| ILR 741 Transmitter               | NEMA 4x enclosure and adapter  |                                 |
| ER 420 (F110) Flow rate/Totalizer | Refer to the ER 420 product data sheet and user manual for additional, detailed information. | -22 ... 176 °F (-30 ... 80 °C)  |
| ER 500 Flow rate/Totalizer        | Refer to the ER 500 product data sheet and user manual for additional, detailed information. | -22 ... 158 °F (-30 ... 70 °C)  |

**NOTE:** The ILR register series is not compatible with 3 in. meters.



## NPN AND PNP SENSOR FOR HAZARDOUS LOCATION

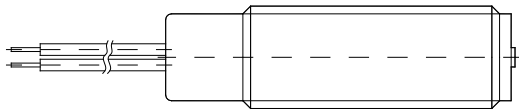

White (□□)

Red (+)

Black (-)



### Technical data

|                                       |   |
|---------------------------------------|---|
| <b>Switching function</b>             | Open collector                                      |
| <b>Output type</b>                    | NPN or PNP 3-wire (2 versions available)            |
| <b>Supply voltage</b>                 | 5 ... 30 V DC ( $I \leq 15 \text{ mA}$ )            |
| <b>Supply current</b>                 | 100 mA max ( $P_{\text{max}} = 0.66 \text{ watt}$ ) |
| <b>Effective internal inductivity</b> | $C_i \leq 12 \text{ nF}$                            |
| <b>Effective internal inductance</b>  | $L_i \leq 0 \mu\text{H}$                            |
| <b>Cable length</b>                   | 118 inch (3 meters)                                 |
| <b>Material</b>                       | Stainless steel 1.4404 (316L)                       |
| <b>Protection class</b>               | IP66 / IP67   |

### Marking

|               |   |
|---------------|---|
| <b>USA</b>    | Intrinsically safe<br>Class I, II, III, Division 1<br>GROUP ABCDEFG T6 to T5                            |
| <b>Canada</b> | Intrinsically safe<br>Class I, Division 1<br>GROUP ABCD T6 to T5<br>Class I, Zone 0, Ex ia IIC T6 to T5 |
| <b>ATEX</b>   | Ex II 1G Ex ia IIC T6 to T4 Ga  |
| <b>IIECEX</b> | Ex ia IIC T6 to T4 Ga   |

## NAMUR SENSOR



CE  
0102

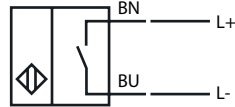
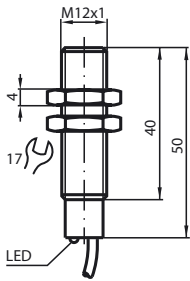

### Technical data

|                                       |  |
|---------------------------------------|--|
| <b>Switching function</b>             | Normally open (NO)   |
| <b>Output type</b>                    | NAMUR 2-wire   |
| <b>Nominal voltage</b>                | U <sub>o</sub> 8.2 V (R <sub>i</sub> approx. 1 kΩ)                       |
| <b>Effective internal inductivity</b> | C <sub>i</sub> ≤ 15 nF; a cable length of 32.8 feet (10 m) is considered |
| <b>Effective internal inductance</b>  | L <sub>i</sub> ≤ 35 μH; a cable length of 32.8 feet (10 m) is considered |
| <b>Switch state indicator</b>         | LED (yellow)   |
| <b>Ambient temperature</b>            | -13 ... 158 °F (-25 ... 70 °C)   |
| <b>Cable length</b>                   | 78 inch (2 meters) (PVC)   |
| <b>Core cross-section</b>             | 0.34 mm <sup>2</sup>   |
| <b>Material</b>                       | Stainless steel 1.4404 (316L)  |
| <b>Protection class</b>               | IP66 / IP67  |

### Marking

|              |                                   |
|--------------|-----------------------------------|
| <b>Namur</b> | CE 0102 / Ex II2G Ex ib IIC T6 Gb |
|--------------|-----------------------------------|

## REED AND HALL BOARD

### Description

Using the reed or hall board, unscaled pulses can be transmitted from the meter to an evaluation instrument like a SPS or a flow computer. The size of the meter can be selected by the slide switch on the circuit board, so all meter sizes

1/2 ... 3 in. are covered with only one circuit board. Further slide switches on the hall board enable various settings, as pulse doubling, pull-up resistance or signal inversion. As well both outputs can be used with only one or two separated power supplies.

### Pulse factors for ILR 740, Reed and Hall board

| Size        | Pulse per gallon | Pulse per liter |
|-------------|------------------|-----------------|
| 1/4 in. LF* | 8213.4           | Approx. 2170    |
| 1/4 in.*    | 1476             | Approx. 390     |
| 1/2 in.     | 378.5            | 100             |
| 3/4 in.     | 249.8            | 66              |
| 1 in.       | 249.8            | 66              |
| 1 in. HF    | 162.8            | 43              |
| 1-1/2 in.   | 64.4             | 17              |
| 2 in.       | 34.1             | 9               |
| 3 in.       | 11.4             | 3               |

\* 2 pulse outputs: 1 reed, 1 hall, standard for all 1/4 in. meters.

### Features

- One reed or hall board for all meter sizes (1/2 in. ... 3 in.)
- Meter size can be selected on the circuit board
- Available in stainless steel 316, aluminum and POM (for PVDF version)



## ER420 [F-SERIES (F012, F018, ER420 (F110), F131)]

### Features

- With the ER420 (F-Series) the following signals types can be processed: Turbine sine wave (coil) pick-ups, reed switches, hall-effect sensors and other active or passive.
- Analog output (0)4 ... 20 mA or 0 ... 10 V DC
- Temperature ranges -22 ... 176 °F (-30 ... 80 °C)
- Modbus via RS232, RS485 or TTL interface
- Scaled pulse output
- HART 7.0 option
- Meter control
- ER420 (F110) Temperature Range
- ATEX markings for gas and dust applications are:  
II 1 G Ex ia IIC T4  
II 1 D Ex iaD 20 IP 65/67 T 100 °C



### Overview application F012

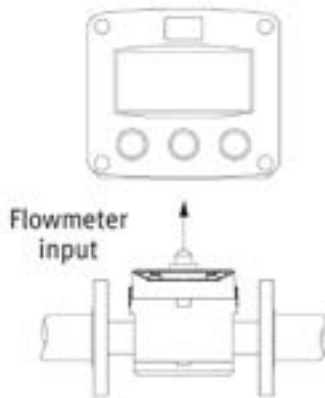

### Overview application ER420 (F110)

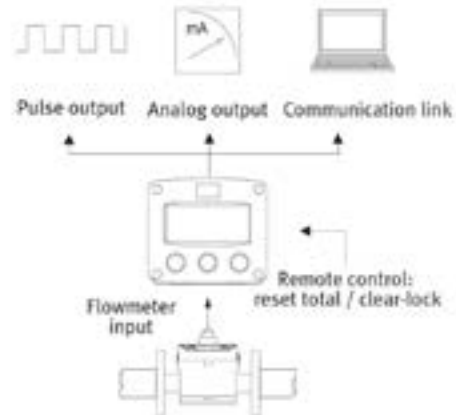

### Overview application F018

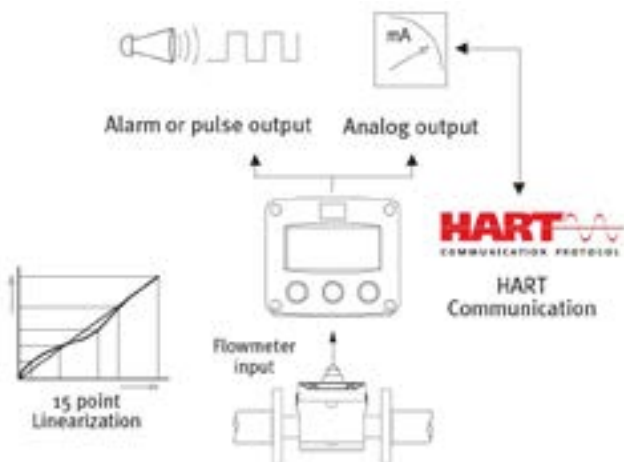

### Overview application F131

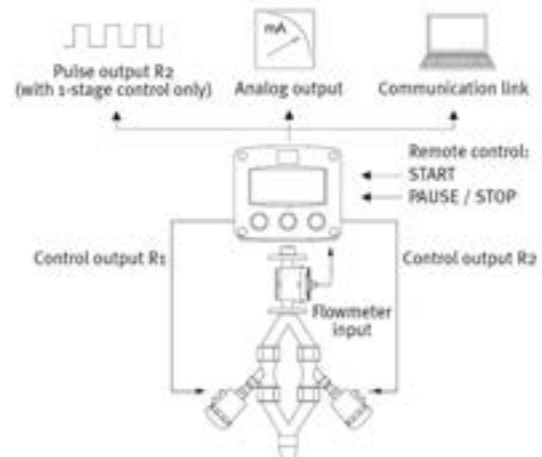

## FLOW MONITOR ER-500

### Input

|                         |               |
|-------------------------|---------------|
| Frequency range         | 1 ... 3500 Hz |
| Frequency accuracy      | ±0.1 %        |
| Over voltage protection | 28 V DC       |

### Outputs

|         |             |
|---------|-------------|
| Analog: | 4 ... 20 mA |
|---------|-------------|

### Totalizing pulse

Optoisolated (ISO) open collector transistor, non-isolated open drain FET.

### Status alarms

Open collector transistor, adjustable flow rate with programmable dead band and phase.

### Modbus

Modbus RTU over RS485, 127 addressable units / 2-wire network, 9600 baud, long integer and single precision IEEE754 formats; retrieve: flow rate, job totalizer, grand totalizer, alarm status and battery level; write: reset job totalizer, reset grand totalizer.

### Protection class

NEMA 4X/IP 66

More information you get in the data sheet "Flow monitor ER-500".



### Features

- Compact size.
- High accuracy and repeatability (0.05 %)
- Flexibility of installation options.
- Robust alarm parameters provide faster warning when something changes in the process or pipeline.
- Advanced connectivity options allow you to connect meters to your network for remote monitoring and process automation capabilities.
- Flexible power options include battery and 4 ... 20 mA loop power, providing a number of benefits including: The ability to install in remote location and be up and running immediately.
- Maintains readings and settings in the event of a power loss, and pro-long the life of the batteries for up to 6 years.
- An updated display and enhanced totalization options provide more flow information at your fingertips, including display of rate and total at the same time and standard, batch and grand totals.

## PART NUMBER CONSTRUCTION

|                                |        |         |   |   |             |   |   |   |    |     |
|--------------------------------|--------|---------|---|---|-------------|---|---|---|----|-----|
| <b>Sample:</b>                 | IND-OG | 1/4" LF | S | S | Reed / Hall | - | 1 | V |    |     |
| <b>Model</b>                   | IND-OG | IND-OG  |   |   |             |   |   |   |    |     |
| <b>Size</b>                    |        |         |   |   |             |   |   |   |    |     |
| 1/8"                           |        | 1/8"    |   |   |             |   |   |   |    |     |
| 1/4" LF                        |        | 1/4" LF |   |   |             |   |   |   |    |     |
| 1/4"                           |        | 1/4"    |   |   |             |   |   |   |    |     |
| <b>Housing</b>                 |        |         |   |   |             |   |   |   |    |     |
| SS316                          |        |         | S |   |             |   |   |   |    |     |
| Aluminum                       |        |         | A |   |             |   |   |   |    |     |
| Kynar PVDF                     |        |         | K |   |             |   |   |   |    |     |
| <b>Oval gear</b>               |        |         |   |   |             |   |   |   |    |     |
| SS316                          |        |         |   | S |             |   |   |   |    |     |
| PPS                            |        |         |   | R |             |   |   |   |    |     |
| <b>Display</b>                 |        |         |   |   |             |   |   |   |    |     |
| Reed / Hall                    |        |         |   |   | Reed / Hall |   |   |   |    |     |
| ILR701                         |        |         |   |   | ILR701      |   |   |   |    |     |
| ILR750                         |        |         |   |   | ILR750      |   |   |   |    |     |
| FXXX                           |        |         |   |   | FXXX        |   |   |   |    |     |
| ER500                          |        |         |   |   | ER500       |   |   |   |    |     |
| <b>Connection</b>              |        |         |   |   |             |   |   |   |    |     |
| BSP                            |        |         |   |   |             |   | 1 |   |    |     |
| NPT                            |        |         |   |   |             |   | 2 |   |    |     |
| <b>O-ring</b>                  |        |         |   |   |             |   |   |   |    |     |
| Viton                          |        |         |   |   |             |   |   | V |    |     |
| Aflas                          |        |         |   |   |             |   |   | A |    |     |
| Kalrez®                        |        |         |   |   |             |   |   | K |    |     |
| EPDM                           |        |         |   |   |             |   |   | J |    |     |
| <b>High viscosity version*</b> |        |         |   |   |             |   |   |   |    |     |
| HV                             |        |         |   |   |             |   |   |   | HV |     |
| <b>Food type</b>               |        |         |   |   |             |   |   |   |    |     |
| FDA                            |        |         |   |   |             |   |   |   |    | FDA |

All 1/8 in. and 1/4 in. meters are furnished with each 1 reed switch and 1 hall signal output in the cover.  
 All displays (ILRXXX or FXXX) are supplied as remote version (cable length 98.5 inch (2.5 meter)).

\* Oval gears in high viscosity version are used at fluid viscosity over 1000 mPas. Not available for sizes **1/8 in.** and **1/4 in LF.**

## PART NUMBER CONSTRUCTION

|                                |        |        |   |     |        |   |   |   |    |     |     |  |
|--------------------------------|--------|--------|---|-----|--------|---|---|---|----|-----|-----|--|
| <b>Sample:</b>                 | IND-OG | 1/2"   | A | Vec | F110   | - | 2 | K |    |     |     |  |
| <b>Model</b>                   | IND-OG | IND-OG |   |     |        |   |   |   |    |     |     |  |
| <b>Size</b>                    |        |        |   |     |        |   |   |   |    |     |     |  |
| 1/2"                           |        | 1/2"   |   |     |        |   |   |   |    |     |     |  |
| 3/4"                           |        | 3/4"   |   |     |        |   |   |   |    |     |     |  |
| 1"                             |        | 1"     |   |     |        |   |   |   |    |     |     |  |
| <b>Housing</b>                 |        |        |   |     |        |   |   |   |    |     |     |  |
| SS316                          |        |        | S |     |        |   |   |   |    |     |     |  |
| Aluminum                       |        |        | A |     |        |   |   |   |    |     |     |  |
| Kynar PVDF                     |        |        | K |     |        |   |   |   |    |     |     |  |
| <b>Oval gear</b>               |        |        |   |     |        |   |   |   |    |     |     |  |
| SS316                          |        |        |   | S   |        |   |   |   |    |     |     |  |
| Vectra                         |        |        |   | Vec |        |   |   |   |    |     |     |  |
| PPS                            |        |        |   | R   |        |   |   |   |    |     |     |  |
| <b>Display</b>                 |        |        |   |     |        |   |   |   |    |     |     |  |
| ILRXXX                         |        |        |   |     | ILRXXX |   |   |   |    |     |     |  |
| FXXX                           |        |        |   |     | FXXX   |   |   |   |    |     |     |  |
| Namur                          |        |        |   |     | Namur  |   |   |   |    |     |     |  |
| PNP                            |        |        |   |     | PNP    |   |   |   |    |     |     |  |
| NPN                            |        |        |   |     | NPN    |   |   |   |    |     |     |  |
| ER500                          |        |        |   |     | ER500  |   |   |   |    |     |     |  |
| <b>Connection</b>              |        |        |   |     |        |   |   |   |    |     |     |  |
| BSP                            |        |        |   |     |        |   | 1 |   |    |     |     |  |
| NPT                            |        |        |   |     |        |   | 2 |   |    |     |     |  |
| Flange ANSI 150 lbs            |        |        |   |     |        |   | 3 |   |    |     |     |  |
| Flange DIN PN16                |        |        |   |     |        |   | 4 |   |    |     |     |  |
| Tri-Clamp®                     |        |        |   |     |        |   | 5 |   |    |     |     |  |
| Flange ANSI 300 lbs            |        |        |   |     |        |   | 6 |   |    |     |     |  |
| <b>O-ring</b>                  |        |        |   |     |        |   |   |   |    |     |     |  |
| Viton                          |        |        |   |     |        |   |   | V |    |     |     |  |
| Aflas                          |        |        |   |     |        |   |   | A |    |     |     |  |
| Kalrez®                        |        |        |   |     |        |   |   | K |    |     |     |  |
| EPDM                           |        |        |   |     |        |   |   | J |    |     |     |  |
| <b>High viscosity version*</b> |        |        |   |     |        |   |   |   |    |     |     |  |
| HV                             |        |        |   |     |        |   |   |   | HV |     |     |  |
| <b>Remote version**</b>        |        |        |   |     |        |   |   |   |    |     |     |  |
| R                              |        |        |   |     |        |   |   |   |    | R   |     |  |
| RXX                            |        |        |   |     |        |   |   |   |    | RXX |     |  |
| <b>Food type</b>               |        |        |   |     |        |   |   |   |    |     |     |  |
| FDA                            |        |        |   |     |        |   |   |   |    |     | FDA |  |

\* Oval gears in high viscosity version are used at fluid viscosity over 1000 mPas.

\*\* Remote version type R with 98.5 inch (2.5 meter) cable length, for longer cables use type **RXX** ("XX" in meter, for 196.85 inch (5 meters) **R5**)

**PART NUMBER CONSTRUCTION**

|                                |        |        |   |   |        |   |   |   |    |     |     |
|--------------------------------|--------|--------|---|---|--------|---|---|---|----|-----|-----|
| <b>Sample:</b>                 | IND-OG | 1" HF  | S | R | ILR700 | - | 4 | J | HV |     |     |
| <b>Model</b>                   | IND-OG |        |   |   |        |   |   |   |    |     |     |
| <b>Size</b>                    |        | 1" HF  |   |   |        |   |   |   |    |     |     |
|                                |        | 1 1/2" |   |   |        |   |   |   |    |     |     |
|                                |        | 2"     |   |   |        |   |   |   |    |     |     |
|                                |        | 3"     |   |   |        |   |   |   |    |     |     |
| <b>Housing</b>                 |        |        |   |   |        |   |   |   |    |     |     |
| SS316                          |        |        | S |   |        |   |   |   |    |     |     |
| Aluminum                       |        |        | A |   |        |   |   |   |    |     |     |
| Kynar PVDF                     |        |        | K |   |        |   |   |   |    |     |     |
| <b>Oval gear</b>               |        |        |   |   |        |   |   |   |    |     |     |
| SS316                          |        |        |   | S |        |   |   |   |    |     |     |
| PPS                            |        |        |   | R |        |   |   |   |    |     |     |
| <b>Display</b>                 |        |        |   |   |        |   |   |   |    |     |     |
| ILR XXX                        |        |        |   |   | ILRXXX |   |   |   |    |     |     |
| FXXX                           |        |        |   |   | FXXX   |   |   |   |    |     |     |
| Namur                          |        |        |   |   | Namur  |   |   |   |    |     |     |
| PNP                            |        |        |   |   | PNP    |   |   |   |    |     |     |
| NPN                            |        |        |   |   | NPN    |   |   |   |    |     |     |
| ER500                          |        |        |   |   | ER500  |   |   |   |    |     |     |
| <b>Connection</b>              |        |        |   |   |        |   |   |   |    |     |     |
| BSP                            |        |        |   |   |        |   | 1 |   |    |     |     |
| NPT                            |        |        |   |   |        |   | 2 |   |    |     |     |
| Flange ANSI 150 lbs            |        |        |   |   |        |   | 3 |   |    |     |     |
| Flange DIN PN16                |        |        |   |   |        |   | 4 |   |    |     |     |
| Tri-Clamp®                     |        |        |   |   |        |   | 5 |   |    |     |     |
| Flange ANSI 300 lbs            |        |        |   |   |        |   | 6 |   |    |     |     |
| <b>O-ring</b>                  |        |        |   |   |        |   |   |   |    |     |     |
| Viton                          |        |        |   |   |        |   |   | V |    |     |     |
| Aflas                          |        |        |   |   |        |   |   | A |    |     |     |
| Kalrez®                        |        |        |   |   |        |   |   | K |    |     |     |
| EPDM                           |        |        |   |   |        |   |   | J |    |     |     |
| <b>High viscosity version*</b> |        |        |   |   |        |   |   |   |    |     |     |
| HV                             |        |        |   |   |        |   |   |   | HV |     |     |
| <b>Remote version**</b>        |        |        |   |   |        |   |   |   |    |     |     |
| R                              |        |        |   |   |        |   |   |   |    | R   |     |
| RXX                            |        |        |   |   |        |   |   |   |    | RXX |     |
| <b>Food type</b>               |        |        |   |   |        |   |   |   |    |     |     |
| FDA                            |        |        |   |   |        |   |   |   |    |     | FDA |

\* Oval gears in high viscosity version are used at fluid viscosity over 1000 mPas.

\*\* Remote version type R with 98.5 inch (2.5 meter) cable length, for longer cables use type **RXX** ("XX" in meter, for 196.85 inch (5 meters) **R5**)

**Control. Manage. Optimize.**

The trademarks appearing in this document are the property of their respective entities. Due to continuous research, product improvements and enhancements, Badger Meter reserves the right to change product or system specifications without notice, except to the extent an outstanding contractual obligation exists. © 2021 Badger Meter, Inc. All rights reserved.